

A | B | C | D | E | F | G | H | I | J | K

1
2
3
4
5
6
7
8

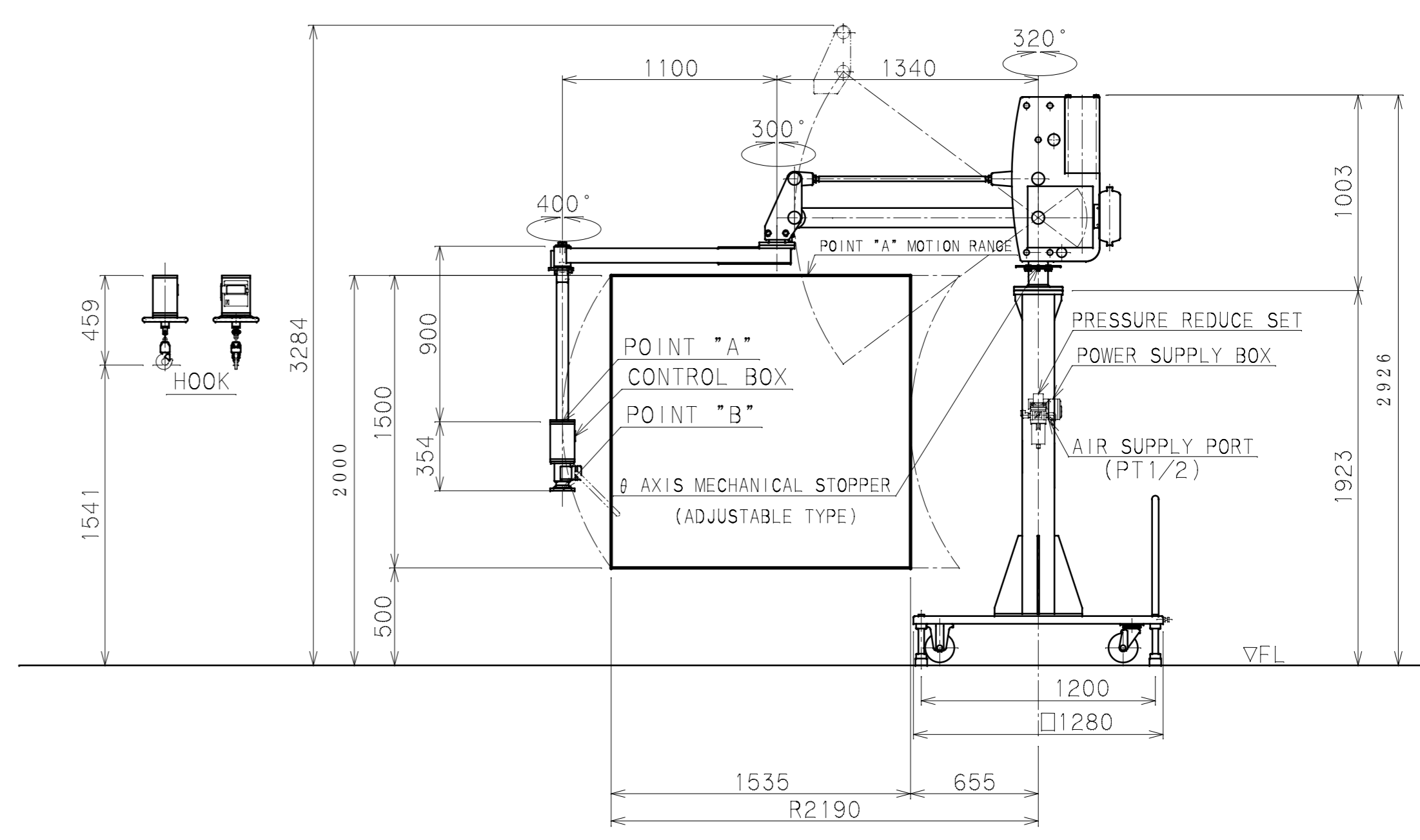
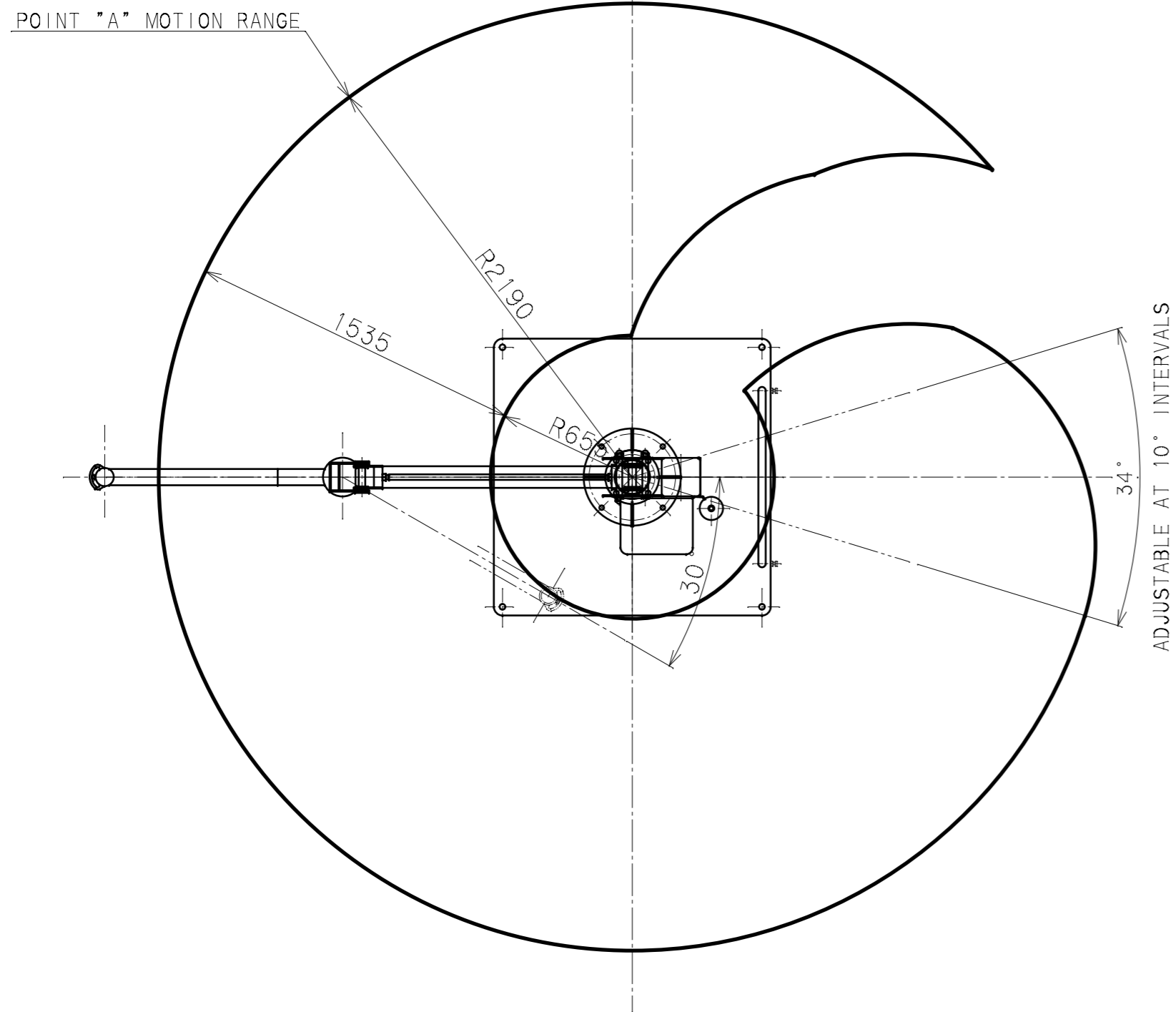

BALAMAN SPECIFICATIONS	
MODEL	U2BMS-125 θ AXIS MECHANICAL STOPPER (ADJUSTABLE TYPE)
MAX. LOAD	125kg (BELOW POINT "A") 113kg (BELOW POINT "B")
MAX. RADIUS	R2190 mm
HORIZONTAL STROKE	1535 mm
VERTICAL STROKE	1500 mm
MAX. WORKING HEIGHT	2000 mm
MAX. MACHINE HEIGHT	3284 mm
AIR SUPPLY	0.54 MPaG
AIR CONSUMPTION	134NL/min (10 SEC CYCLE)
POWER SUPPLY	SINGLE-PHASE AC85~AC264V 50/60Hz 0.1KVA
CONTROL METHOD	
COATING	LN-15 (JPMA BLACK) LN-93 (JPMA WHITE)
MAIN UNIT MASS	APPROX. 180kg
BASE UNIT MASS	APPROX. 600kg
CONTROL BOX MASS	12kg
WORKPIECE MASS	kg
REMARKS	ACCESSORIES: PRESSURE REDUCE SET : POWER SUPPLY BOX